

## Water to water Screw Heat Pump

### EWW(D)(H)(S)~J-SS

- Compact line with single refrigerant circuit
- For comfort, high temperature and industrial process applications
- Available with LOW GWP refrigerant



<https://www.eurovent-certification.com>

---

<b><u>Table of content</u></b>	
<b><u>Features and benefits</u></b> .....	<b>3</b>
<b><u>General characteristics</u></b> .....	<b>6</b>
<b><u>Nomenclature</u></b> .....	<b>8</b>
<b>Options</b>	
<b><u>Standard options</u></b> .....	<b>9</b>
<b><u>Options on request</u></b> .....	<b>10</b>
<b>Technical specifications</b>	
<b><u>EWWD J-SS</u></b> .....	<b>13</b>
<b><u>EWWH J-SS</u></b> .....	<b>15</b>
<b><u>EWWS J-SS</u></b> .....	<b>17</b>
<b><u>Electrical specifications</u></b> .....	<b>19</b>
<b><u>Sound levels</u></b> .....	<b>20</b>
<b>Operating limits</b>	
<b><u>EWWD J-SS</u></b> .....	<b>21</b>
<b><u>EWWH J-SS</u></b> .....	<b>22</b>
<b><u>EWWS J-SS</u></b> .....	<b>23</b>
<b><u>Installation notes</u></b> .....	<b>26</b>
<b><u>Technical specifications</u></b> .....	<b>27</b>

## Features and benefits

**Low operating cost High Flexibility and Reliability.** This range is the result of careful design, aimed to optimize the energy efficiency of the units, with the objective of bringing down operating costs and improving installation profitability, effectiveness and economical management.

The series feature a Daikin design single screw compressor, direct expansion plate to plate evaporator and shell & tube condenser for maximum heat transfer and low refrigerant pressure drops.

The EWW(D)(H)(S)~J-SS range is available in SILVER efficiency and STANDARD sound version, 7 sizes covering the following capacity range:

- **EWW~J-SS** featuring R-134a refrigerant: from 120 up to 284 kW in cooling and from 144 up to 347 kW in heating\*;
- **EWWH~J-SS** featuring R-1234ze refrigerant: from 89 up to 201 kW in cooling and from 106 up to 243 kW in heating\*;
- **EWWS~J-SS** featuring R-513A refrigerant: from 115 up to 272 kW in cooling and from 140 up to 388 kW in heating\*.

(\* low temperature application)

Compressor soundproof system option is available to further reduce sound level.

**Infinite capacity control.** Cooling capacity control is infinitely variable by means of a single screw semi-hermetic compressor controlled by microprocessor system. Each unit has infinitely variable capacity control from 100% down to 25%. This modulation allows the unit to perfectly match the cooling or heating load and consequently providing without any leaving water temperature fluctuation. This water temperature fluctuation is avoided with a stepless control.

With a compressor load step control in fact, the compressor capacity, at partial loads, will be too high or too low compared for example to the building cooling load. The result is an increase in energy costs, particularly at the part-load conditions at which the unit operates most of the time.

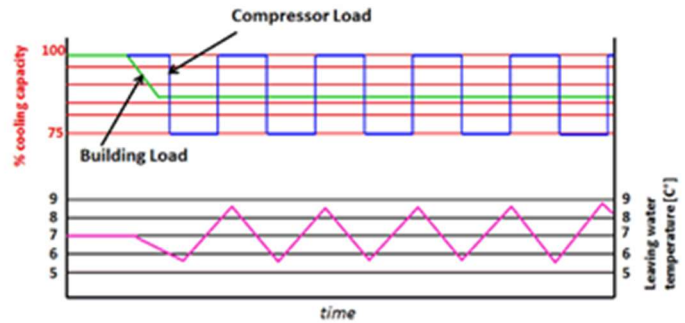

EWLT fluctuation with steps capacity control (4 steps)

Units with stepless regulation offer benefits that the units with step regulation are unable to match: the ability to follow the system energy demand at any time and the possibility to provide steady outlet water temperature without deviations from the set-point.

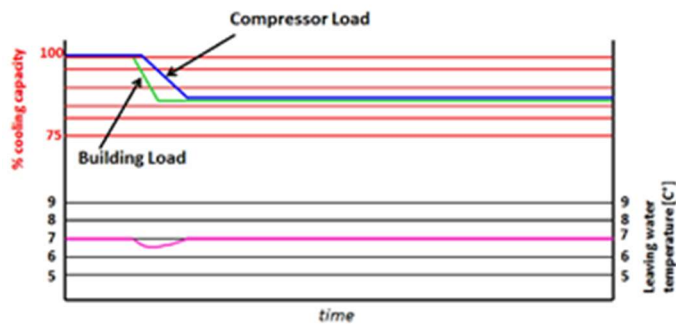

EWLT fluctuation with stepless capacity control

**Low environmental impact.** DAIKIN J- series is designed to operate with R-134a, R-1234ze and R-513A refrigerants. These are ecological refrigerant with zero ODP (Ozone Depletion Potential) but with different GWP index (Global Warming Potential):

- R-1234ze → GWP 7
- R-513A → GWP 630
- R-134a → GWP 1430

These are Greenhouse gases, meaning that they absorb and emit radiant energy within the thermal infrared range causing the well-known Greenhouse effect. One of the primary greenhouse gases in the atmosphere is carbon dioxide. Basically, greenhouse gases (GHGs) warm the Earth by absorbing energy and slowing the rate at which the energy escapes to space, acting like a blanket insulating the Earth. The Global Warming Potential is a measure of how much energy the emissions of 1 ton of a gas will absorb over a given period (usually 100 years is considered), relative to the emissions of 1 ton of carbon dioxide. The larger the GWP, the more that a given GHG warms the Earth compared to carbon dioxide over that time.

The European Union aims to reduce the environmental impact of fluorinated gases via regulation. The first F-gas regulation EC 842/2006 focused on reducing emissions mostly by preventing leaks in systems and enforcing responsible end-of-life recovery and destruction of these gases.

The European Union has recently published an updated F-gas regulation (517/2014). This regulation entered into force from 1st January 2015, replacing the previous version (842/2006) includes among the phase down of HFC refrigerants.

Considering the overall quantity of HFC supplied to Europe in 2015 (100%) the phase down program aims to reduce that quantity down to 21% by 2030.

The introduction of low GWP refrigerants is the answer to the need of reducing the environmental impact and carbon emissions attaining the European F-GAS regulation targets.

**Compactness.** The EWW(D)(H)(S)~J-SS series is designed to achieve the smallest possible footprint making this product the ideal solution to allow easy indoor installation for restricting spaces or refitting operations and easy transportation. Thanks to the stacked installation option, it is also possible to further reduce the installation space of two units.

**Application flexibility.** The EWW(D)(H)(S)~J-SS series can satisfy a large variety of applications not limited to traditional comfort cooling and heating but industrial process, brine water, ice storage and high temperature heat pump (up to 75°C).

**Outstanding reliability.** Units are equipped with rugged compressor design with advanced and robust composite compressor gate-rotors material. Units are factory tested before shipment.

**Superior control logic.** The EWW(D)(H)(S)~J-SS series is enjoying MicroTech 4 controller that provides an easy to use control environment. The control logic is designed to provide highest efficiency performances and continuous operation. Easy interface with Lon Works, BACnet, TCP/IP or Modbus communication protocols.

**Codes and Certifications.** The EWW(D)(H)(S)~J- series is CE marked, complying with European directive in force concerning manufacturing and safety. Units are designed and manufactured in accordance with applicable selections of the following:

- Construction of pressure vessel 2014/68/EU Machinery Directive 2006/42/EC
- Low Voltage 2014/35/EU
- Electromagnetic Compatibility 2014/30/EU
- Electrical & Safety codes EN60204-1/EN61439-1/EN61439-2 Manufacturing & Quality Standards UNI EN ISO 9001:2008 Environmental Management System UNI EN ISO 14001:2004 Health & Safety Management System BS OHSAS 18001:2007

**Additional information related to F-GAS Regulation (EU) No 517/2014 of the European Parliament and of the Council of 16th April 2014 on fluorinated greenhouse gases and repealing Regulation (EC) No 842/2006.**

Unit model	Refrigerant type	Refrigerant GWP	N. of circuits	Refrigerant charge circuit 1 (kg)	Refrigerant charge circuit 1 (TCO <sub>2</sub> Eq)
EWWH090J-SS	R-1234ze	7	1	18	0.1
EWWH110J-SS	R-1234ze	7	1	35	0.2
EWWH120J-SS	R-1234ze	7	1	34	0.2
EWWH130J-SS	R-1234ze	7	1	37	0.3
EWWH150J-SS	R-1234ze	7	1	37	0.3
EWWH180J-SS	R-1234ze	7	1	38	0.3
EWWH200J-SS	R-1234ze	7	1	38	0.3

Unit model	Refrigerant type	Refrigerant GWP	N. of circuits	Refrigerant charge circuit 1 (kg)	Refrigerant charge circuit 1 (TCO <sub>2</sub> Eq)
EWWS120J-SS	R-513A	630	1	18	11.3
EWWS140J-SS	R-513A	630	1	35	22.1
EWWS150J-SS	R-513A	630	1	34	21.4
EWWS180J-SS	R-513A	630	1	37	23.3
EWWS210J-SS	R-513A	630	1	37	23.3
EWWS240J-SS	R-513A	630	1	38	23.9
EWWS270J-SS	R-513A	630	1	38	23.9

Unit model	Refrigerant type	Refrigerant GWP	N. of circuits	Refrigerant charge circuit 1 (kg)	Refrigerant charge circuit 1 (TCO <sub>2</sub> Eq)
EWWD120J-SS	R-134a	1430	1	18	25.7
EWWD140J-SS	R-134a	1430	1	35	50.1
EWWD150J-SS	R-134a	1430	1	34	48.6
EWWD180J-SS	R-134a	1430	1	37	52.9
EWWD210J-SS	R-134a	1430	1	37	52.9
EWWD250J-SS	R-134a	1430	1	38	54.3
EWWD280J-SS	R-134a	1430	1	38	54.3

Note: The refrigerant charge is subject to change and it depends on the final unit construction. For detailed refrigerant charge refer to the unit nameplate.

## **General characteristics**

**Cabinet and base frame.** The cabinet is made of galvanized steel sheet and painted to provide a high resistance to corrosion. Color is Ivory White (Munsell code 5Y7.5/1) ( $\pm$ RAL7044). The base frame has an eyehook to lift the unit with ropes for an easy installation. The weight is uniformly distributed along the profiles of the base to simplify the unit installation.

**Single Screw Compressor.** The compressor is Daikin design semi-hermetic single-screw type with gate-rotors made of carbon impregnated engineered composite material. The compressor has a slide managed by the unit microprocessor for infinitely modulating the capacity between 100% to 25%. An integrated high efficiency oil separator maximizes the oil separation and standard start is Wye-Delta (Y- $\Delta$ ) type.

**Refrigerant.** DAIKIN J-series is available with both HFO and HFC refrigerants:

- EWWD~J- models operating with R-134a (GWP 1430);
- EWWH~J- models operating with R-1234ze (GWP 7);
- EWWS~J- models operating with R-513A (GWP 630).

NOTE: The fourth digit in DAIKIN nomenclature identifies the refrigerant type for the unit.

**Evaporator.** The unit is equipped with a direct expansion plate to plate type evaporator. This heat exchanger is made of stainless-steel brazed plates and is covered with a 20mm closed cell insulation material. Evaporator water connections are provided with Victaulic kit (as standard). The evaporator has 1 circuit (one compressor) and is manufactured in accordance to PED approval. Flow switch on evaporator standard factory mounted. Water filter is standard, it is supplied shipped loose and must be fitted on the unit by the installer.

**Condenser.** The unit is equipped with shell & tube condenser with water flowing inside the tubes and refrigerant condensing outside. The bottom of the condenser is provided with subcooler section for better refrigerant capacity. The tubes are enhanced for maximum heat transfer and rolled into steel tube sheet and sealed. The tubes are individually replaceable. The condensers are designed according to the 97/23/EC directive (PED). The water side is designed for 16 bar of maximum operating pressure; vents and drain are provided. Condenser water filter is not supplied and not available as option.

**Electronic expansion valve.** Unit is equipped with latest technology electronic expansion valve to achieve precise control of refrigerant mass flow. As today's system requires improved energy efficiency, tighter temperature control and wide operating range, the application of electronic expansion valve is the recommended solution. Electronic expansion valve provides unique features such as short opening and closing times, high resolution, positive shut-off function eliminating the need for additional solenoid valve, continuous modulation of mass flow with reduced stress in the refrigerant circuit.

**Refrigerant Circuit.** Each unit has one independent refrigerant circuit that includes:

- Single screw compressor with integrated oil separator;
- Refrigerant charge;
- Evaporator;
- Condenser;
- Electronic expansion valve;
- Liquid line shut off valve;
- Sight glass with moisture indicator;
- High pressure switch;
- High pressure transducer;
- Low pressure transducer;
- Oil pressure transducer;
- Suction temperature sensor.

**Electrical Panel.** Power and control sections are located into the main electrical panel IP54 designed. The main panel doors are interlocked to the main switch (standard) in order guarantee safe operation when doors are opened.

**Power Section** The power section includes compressor protection devices and compressor starters and control circuit power supply.

**MicroTech 4 Controller.** The new MicroTech 4 controller is installed as standard.

MicroTech 4 built-in terminal has the following features:

- Liquid crystal display with white back lighting, supports Unicode fonts for multi-lingual;
- Key-pad consisting of 3 keys;
- Push'n'roll control for an increased usability;
- Flash memory to protect the data;
- Password access to modify the setting;
- Application security to prevent application tampering or hardware usability with third party applications;
- Alarm history memory to allow an easy fault analysis.

The controller gives the possibility to check the most relevant control parameters and to modify unit set points. A built-in display shows unit operating status. Additionally, temperatures and pressures of water, refrigerant, programmable values, set points can be accessed based on a preset list of user profiles.

A sophisticated software with adaptive logic, selects the most energy efficient combination of compressors and electronic expansion valve position to keep stable operating conditions to maximize unit energy efficiency and reliability. MicroTech 4 protects critical components based on external signals from onboard sub system (such as motor temperatures, refrigerant and oil pressures and temperatures, correctness of phase sequence, pressure switches and freezing of heat exchanger).

The input coming from high-pressure switches cuts all digital output from the controller in less than 50ms, as an additional security for the equipment. Fast program cycle (less than 200ms) for a precise monitoring of the system and sub systems. Floating point calculations supported for increased accuracy in Pressure / Temperature conversions.

**Main control features** are (for more information refer to Unit Control Manual):

- Management of the compressor stepless capacity;
- Control of cooling or heating leaving water temperatures;
- Optimized management of compressor load;
- Soft Load (optimized management of the compressor load during the start-up);
- Start at high heat exchanger water temperature;
- Re-start in case of power failure (automatic/manual);
- Visualization of:
  - cooling and heating entering/leaving water temperature of heat exchangers;
  - outdoor ambient temperature;
  - condensing-evaporating temperature and pressure, suction and discharge superheat for each circuit;
  - hours and starts counter for compressors and pumps;
  - status safety devices;
- Return Reset (Set Point Reset based on return water temperature);
- Set point Reset (optional);
- Unit enabled to work in partial failure condition;
- Managed operations during critical conditions:
  - High ambient temperature;
  - High thermal load;
  - Startup with high and low differential operating conditions;
  - Startup with high entering water temperature in cooling mode;
  - Startup with low entering water temperature in heating mode.

**Control additional features**

- Application and system upgrade with commercial SD cards;
- Save/Restore of configuration parameters with a commercial SD card;
- Ethernet port for remote or local servicing using standard web browsers;
- Two different sets of default parameters could be stored for easy restore;
- Daikin on Site connectivity for cloud-based services.

**Safety device / logic** (for more information refer to Unit Control Manual):

- High pressure (switch);
- High pressure (transducer);
- Low pressure (transducer);
- High discharge temperature;
- High motor winding temperature;
- Low pressure ratio;
- High oil pressure differential;
- Low oil pressure;
- No pressure changes at start.

**System security:**

- Phase monitor;
- Freeze protection.

**Regulation type:** Proportional-Integral-Derivative (PID) type based on the evaporator leaving water temperature set point (cooling mode) or based on the condenser leaving water temperature set point (heating mode).

**Supervising systems (on request) MicroTech 4 remote communication:** MicroTech 4 controlled is capable to communicate with BMS systems based on the most common protocols such as: Modbus, Lon Works, BACnet IP and MS/TP (class 4), Ethernet TCP/IP. Communication cards (optional) are to be selected according to the required communication protocol.

**Nomenclature**

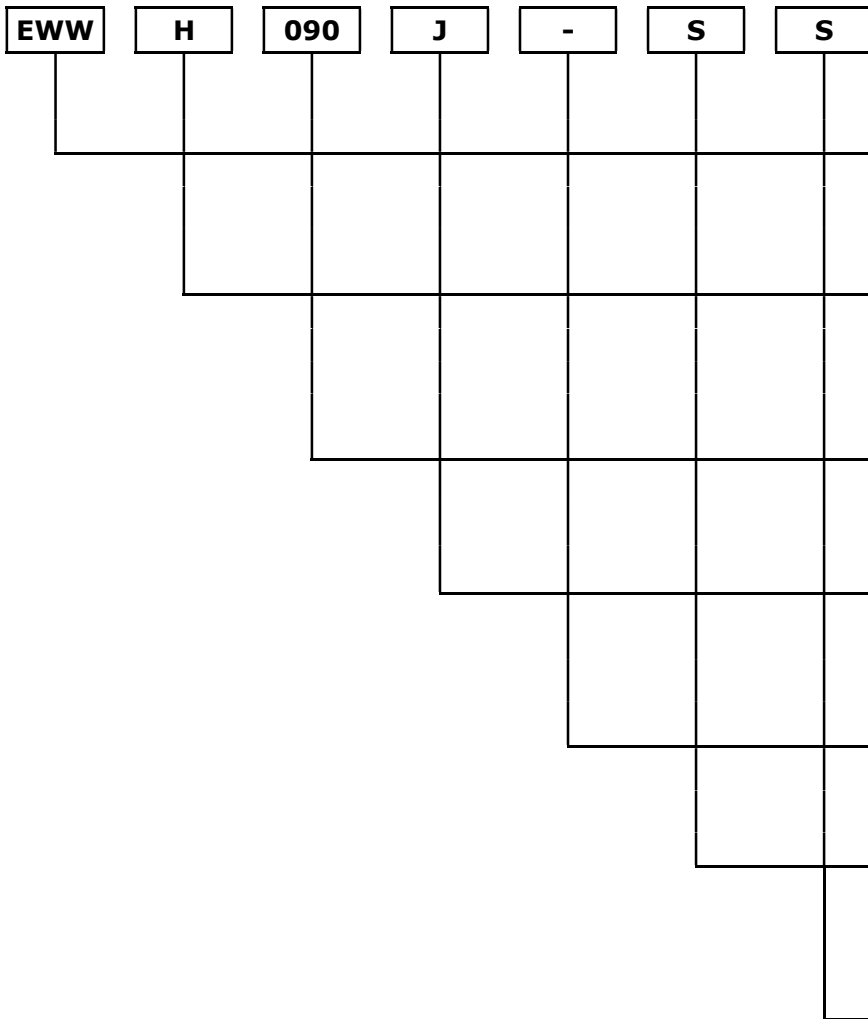

**Unit Type**

**EWW = Water cooled unit**

**Refrigerant**

**D = R-134a**

**H = R-1234ze**

**S = R-513A**

**Cooling Capacity Class [kW]**

**3-digit code**

**Series**

**J = Water cooled single screw unit**

**Compressor drive**

**- = Fix speed**

**Efficiency level**

**S = Silver Efficiency**

**Sound level**

**S = Standard sound**



**Standard options (Supplied on basic unit)**

**Heat Pump Version – including Pursuit Mode (option 07a – STANDARD).** Reversibility on the water side. Unit capability to follow two different set points (cooling mode or heating mode, but not contemporary). During “cooling mode operation”, unit microprocessor is following evaporator leaving water temperature set point. When the unit is switched to “heating mode operation”, the unit microprocessor is following condenser leaving water temperature set point. Cooling or heating mode operation can be selected by means of a dedicated switch installed on the unit electrical panel. If communication card is selected, cooling or heating mode operation can be managed by BMS. Heat Pump Version option includes 20 mm condenser insulation (option 33).

In case pursuit mode operation is enabled via Microtech 4 unit controller will follow both set points (cooling and heating). When the first set point is satisfied, either the cold or the hot one, the unit will maintain that set point only, ignoring the other one. This operation mode is ideal for applications with cooling and heating loads balanced. Pursuit mode operation is not recommended in case of unbalanced loads (e.g. 80% of nominal cooling load and 20% of nominal heating load).

**Wye-Delta compressor starter (Y-D) (option 05 – STANDARD).** Standard starting method used for screw chillers characterized by a low starting current than direct-on-line starting. The motor is started with Y-connection (STAR) and accelerated as far as possible, then switched to D-connection (DELTA) - *Option incompatibility: 06.*

**Double set point (option 10 – STANDARD).** Possibility to pre-set two different set points one for unit running in cooling mode and one for unit running in heating mode.

**Phase monitor (option 13 – STANDARD).** Installed in the electrical panel to protect the unit in case of phase loss or phase reversal - *Option incompatibility: 15.*

**Evaporator Victaulic kit (option 20 - STANDARD).** Victaulic joints and counter-pipes.

**20 mm evaporator insulation (option 29 – STANDARD).** Thermal insulation of the evaporator - *Option incompatibility: 08.*

**20 mm condenser insulation (option 33 – STANDARD).** Thermal insulation of the condenser (included with option 07a – Heat Pump Version).

**Condenser Victaulic kit (option 36 - STANDARD).** Victaulic joints and counter-pipes - *Option incompatibility: 26-50.*

**Condenser water design pressure 16 bar (option 47 – STANDARD).**

**Condenser two passes (option 52 – STANDARD).** Condenser with two passes water side design. Water connections cannot be reversed - *Option incompatibility: 54B.*

**Evaporator flow switch (option 58 – STANDARD).** Paddle flow switch shipped loose. Refer to unit installation manual for more details.

**Electronic expansion valve (option 60 – STANDARD).**

**Discharge line shut-off valve (option 61 – STANDARD).** Installed on the discharge line of the compressor to facilitate maintenance operations.

**Suction line shut-off valve (option 62 – STANDARD).** Installed on the suction line of the compressor to facilitate maintenance operations.

**Hour run meter (option 68 – STANDARD).** Standard functionality of unit controller to count the number of working hours of compressor.

**General fault contactor (option 69 – STANDARD).** Standard functionality of unit controller to communicate and give information about a general fault of the unit.

**Set point reset, demand limit and alarm from an external device (option 90 – STANDARD).** Standard functionality of unit controller. Set point reset: possibility to re-set the water temperature set point by means of a 4-20 mA signal. Demand Limit: possibility to limit unit capacity by means of 4-20 mA signal. Alarm from external device: unit controller capability to receive an external alarm signal. The user can decide whether this alarm signal will stop the unit controller or not. Refer to unit control manual for more information.

**Main switch interlocked doors (option 97 – STANDARD).** Electrical panel’s doors are interlocked with the main switch isolator for safe operation.

**Emergency stop (option 98 – STANDARD).** Safety device placed on the control panel which can be manually activated to stop immediately the chiller in case of danger.

**Master/Slave (option 128 – STANDARD).** Standard controller functionality allowing to connect up to 4 units and providing basic sequencing functionalities such as balancing of working hours of unit & compressors and balancing of unit loads amongst connected units. An additional probe (PT1000 or NTC10K, not provided by Factory) must be installed on the common water header and connected to the master unit.

## Options on request

### MECHANICAL OPTIONS

**Brine Version (option 08 – ON REQUEST).** Required in case of unit operation with chilled water temperatures below +4°C. The unit must operate with glycol mixture (with ethylene or propylene glycol). Refer to the unit operating envelope for more information about minimum allowed evaporator leaving water temperatures. - *Option incompatibility: 29.*

**Condenser double flanges kit (option 26 – ON REQUEST).** Condenser water connections are provided with flange, counter-flanges and gaskets, bolted together with fasteners and nuts. Installer must weld the counter-flange to the water pipe existing on site - *Option incompatibility: 36.*

**Cu-Ni 90-10 condenser tubes (option 50 – ON REQUEST).** Condenser tubes made of Cu-Ni 90-10 material and Cu-Ni 90-10 tube sheets cladding. Epoxy ceramic coating of water headers and sacrificial anodes. Cupronickel is highly resistance to corrosion in seawater; for this reason, it is used for piping in seawater system. Unit performances may differ from standard. Contact local Daikin office for more details. When selecting option 50, condenser double flanges kit option (option 26) must be selected as well - *Option incompatibility: 36.*

**Condenser four passes (option 54B – ON REQUEST).** Condenser with four passes water side design allowing to run the unit with higher condenser water  $\Delta T$  20°C (Contact the factory for more details). Water connections cannot be reversed - *Option incompatibility: 52.*

**High-pressure side manometers (option 63 – ON REQUEST).**

**Low-pressure side manometers (option 64 – ON REQUEST).**

**Compressor soundproof system (option 76-b – ON REQUEST).** High performance soundproof cabinet installed around compressor and specifically designed in order to decrease unit sound levels ( $\sim$ -3dB(A)) - *Option incompatibility: 133.*

**Double pressure relief valve with diverter (option 91 – ON REQUEST).** Double pressure relief valve with diverter allows to use one valve while isolating the other from the system during maintenance operations.

**High temperature kit (option 111 – ON REQUEST) Only for EWWH~J-SS R-1234ze range.** Required to reach condenser leaving water temperature up to 75°C (note: refer to operating envelope and to chiller selection software for detailed information). Specifically selected components are used in order to allow the unit to operate at such conditions.

**Refrigerant leak detection (option 121 – ON REQUEST).** Electronic device (shipped loose) for automatic detection of refrigerant leak. The leak detection device should be installed within the machinery room in the most appropriate location (refer to the leak detection device installation manual). When leak above a pre-set concentration of refrigerant (2000 ppm) is detected, signal is sent to unit controller (a specific alarm is visualized on the unit microprocessor's display). The Factory does not supply interconnecting cables between leak detection device and unit controller.

**Stacked installation (option 133 – ON REQUEST).** Stacked installation of two units that can operate in stand-alone or with Master/Slave control - *Option incompatibility: 76b.*

**High Evaporator Leaving Water Temperature (option 189 – ON REQUEST) Only for EWWH~J-SS R-1234ze range.** With this option is possible to select R1234ze fixed speed units up to 25°C evaporator leaving temperatures.

**ELECTRICAL OPTIONS**

**Soft starter (option 06 – ON REQUEST).** Electronic starting device adopted to reduce the mechanical stress during compressor start-up - *Option incompatibility: 05-11.*

**Compressor thermal overload relays (option 11 – ON REQUEST).** This device, with also internal motor protection (thermistor probes, buried deep in each phase of the stator windings, that provide protection against high temperatures are offered as standard), delivers a high level of safety for the compressor motor - *Option incompatibility: 06-95.*

**Under/over voltage control (option 15 – ON REQUEST).** Electronic device to protect the unit in case of phase loss, wrong phase sequence or voltage exceeding minimum and maximum allowed values. *Option incompatibility: 13.*

**Energy meter (option 16 – ON REQUEST).** Electronic device installed within unit electrical panel that measures and display supply line individual phase voltage and current, active and reactive power input, active and reactive energy consumption. An integrated RS485 module allows Modbus communication to an external BMS.

**Capacitors for power factor correction (option 17 – ON REQUEST).** Device installed within unit electrical panel to increase the efficiency of system, eliminating potential penalties due to low power factor.

**Current limit (option 19 – ON REQUEST).** Enabled from the unit controller, limits the maximum absorbed current of the unit to a specific value set by the user (set point can be set in the unit display or can be changed from an external 4-20 mA signal).

**Condenser flow switch (option 59 – ON REQUEST).** Paddle flow switch shipped loose. Refer to unit installation manual for more details.

**Compressor circuit breakers (option 95 – ON REQUEST).** Protection device including protection from current overload and overcurrent. In case this option is selected, compressor fuses are removed - *Option incompatibility: 11.*

**Ground fault relay (option 102 – ON REQUEST).** Unit shuts down in case of ground fault is detected.

**Daikin on site modem with antenna (opt. code 155).** With Daikin On Site it is possible to have complete access to the unit controller through the cloud. The unit is equipped with a modem and a GSM card providing autonomous internet connection. As alternative, a LAN connection can be used if available. - *Option incompatibility: 182.*

The main functionalities of DoS are:

- predefined set of data points (~300 to >500 per controller/plant);
- predefined Read/Write access to data points;
- predefined set of dashboards;
- functionality for users to create their own dashboards;
- alarm application and alarm history;
- alarm notification via email;
- scheduling of alarm notification;
- WEB-Access to local HMI;
- Dynamic WEB-Graphic;
- possibility to upgrade firmware and software from remote (for some user roles);
- history log for cloud-based user interactions (e.g. change of a set point);
- scheduler application;
- documentation folder (E.g. release notes).

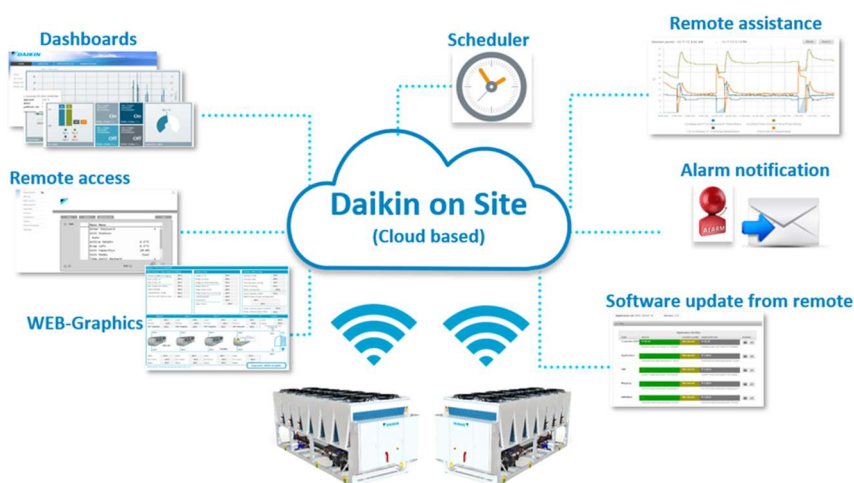

**Modbus RTU MSTP (option 180 – ON REQUEST).** - *Option incompatibility: 181-182.*

**BACnet MSTP (option 181 – ON REQUEST).** - *Option incompatibility: 180-182.*

**BACnet IP (option 182 – ON REQUEST).** - *Option incompatibility: 155-180-181.*

**iCM Standard (option 184 – ON REQUEST).** By selecting this option is possible to achieve the control of the primary loop without need of additional control panel. The option adds much more functionalities than those provided by standard Master/Slave. Contact the factory for more detailed information.

## **INSTALLATION OPTIONS**

**Rubber antivibration mounts (option 75 – ON REQUEST).** Rubber antivibration mounts to be installed under the unit base frame during installation.

## **OTHER OPTIONS**

**Container kit (option 71 – ON REQUEST).** The container kit is composed by a wooden pallet structure, positioned below the unit, specially designed to ease loading/unloading operation into the container with a forklift. Kit is equipped with anchoring points in order to fix the unit and to avoid any movement during loading/unloading operation. *Option incompatibility: 112.*

**Transport kit (option 112 – ON REQUEST).** Transport kit is composed by a wooden pallet covered by a foam lay that is located between the unit and the pallet to increase shock absorption during transportation. With this option use of forklift is allowed. *Option incompatibility: 71.*

## **Marine Version (option 167 – on request).**

In marine applications, units may be exposed to specific operating conditions (depending on the installation), such as:

- Pitch and roll conditions can affect the refrigerant and oil circuits operation;
- Vibrations, with impact on the mechanical parts of the unit;
- Sea water (on condenser side).

Marine Version is composed by a set of solutions in order to meet every specific need (as standard, included in opt. 167):

- Oil sump to ensure proper oil return, in pitch and roll operation;
- Dedicated Circuit breaker in order to improve electrical protection of the auxiliary circuits;
- Running lamps and digital outputs signal.

To select unit with opt. 167 refer to CSS web.

In addition to the above further customization are possible, such as:

- Cu-Ni condenser (Option 50 in price list) – to prevent damages on condenser due to sea water application;
- Performance of the unit will be different than standard;
- Halogen free cables and insulation;
- Power Supply 690V/60Hz;
- Power Supply 440V/60Hz;
- Nitrogen charge in heat exchangers before shipment, to preserve reliability for long term storage period of the unit;
- Marine certification for heat exchangers (i.e. DNV, ASME...).

Contact factory for feasibility analysis and quotations.

EWWD~J-SS

MODEL		EWWD120 J-SS	EWWD140 J-SS	EWWD150 J-SS	EWWD180 J-SS	EWWD210 J-SS	EWWD250 J-SS	EWWD280 J-SS
<b>COOLING PERFORMANCE <sup>(1)</sup></b>								
Capacity - Cooling	kW	119.7	145.7	154.3	177.3	207.3	255.3	284.1
Capacity control - Type		Stepless	Stepless	Stepless	Stepless	Stepless	Stepless	Stepless
Capacity control - Minimum capacity	%	25	25	25	25	25	25	25
Unit power input - Cooling	kW	28.0	34.0	39.5	45.3	50.4	59.9	70.0
EER		4.28	4.28	3.91	3.92	4.11	4.26	4.06
SEER <sup>(2)</sup>		3.89	4.74	4.58	4.59	4.81	5.09	4.42
$\eta_{s,c}$ <sup>(2)</sup>	%	147.6	181.6	175.2	175.6	184.4	195.6	168.8
SEPR <sup>(3)</sup>		5.53	6.00	5.37	5.82	6.10	6.88	6.16
IPLV		5.18	5.06	5.06	5.05	5.16	5.70	4.88
<b>HEATING PERFORMANCE <sup>(4)</sup></b>								
<b>LOW TEMP. APPLICATION</b>								
Capacity - Heating	kW	144.2	175.4	189.8	217.8	252.2	308.4	347.4
COP		5.20	5.20	4.84	4.85	5.04	5.17	4.98
SCOP <sup>(5)</sup>		4.40	4.34	4.14	4.15	4.24	4.46	4.21
$\eta_{s,h}$ <sup>(5)</sup>	%	168.0	165.6	157.6	158.0	161.6	170.4	160.4
<b>INTERMEDIATE TEMP. APPLICATION</b>								
Capacity - Heating	kW	138.9	168.8	185.0	211.7	244.3	300.7	340.5
COP		4.17	4.17	3.91	3.91	4.06	4.03	3.91
<b>MEDIUM TEMP. APPLICATION</b>								
Capacity - Heating	kW	133.8	162.5	179.9	206.0	234.7	293.8	333.7
COP		3.41	3.40	3.23	3.23	3.25	3.27	3.17
<b>DIMENSIONS <sup>(6)</sup></b>								
Height	mm	1020	1020	1020	1020	1020	1020	1020
Width	mm	913	913	913	913	913	913	913
Length	mm	2684	2684	2684	2684	2684	2684	2684
<b>WEIGHT <sup>(6)</sup></b>								
Unit Weight	kg	1177	1233	1334	1366	1416	1600	1607
Operating Weight	kg	1211	1276	1378	1415	1473	1663	1675
<b>HEAT EXCHANGER - EVAPORATOR</b>								
Type <sup>(7)</sup>		PHE	PHE	PHE	PHE	PHE	PHE	PHE
Water Volume	l	14	18	14	17	20	26	26
Water flow rate <sup>(1)</sup>	l/s	5.70	7.00	7.40	8.50	9.90	12.20	13.60
Water pressure drop <sup>(1) (8)</sup>	kPa	15.0	14.0	43.0	40.0	35.0	28.0	34.0
<b>HEAT EXCHANGER - CONDENSER</b>								
Type <sup>(7)</sup>		S&T	S&T	S&T	S&T	S&T	S&T	S&T
Water Volume	l	20	20	23	25	29	29	32
Water flow rate <sup>(1)</sup>	l/s	7.10	8.60	9.30	10.70	12.40	15.20	17.00
Water pressure drop <sup>(1) (8)</sup>	kPa	20.0	13.0	11.0	11.0	15.0	17.0	27.0
<b>COMPRESSOR</b>								
Type		Single Screw	Single Screw	Single Screw	Single Screw	Single Screw	Single Screw	Single Screw
Oil charge	l	13	13	13	13	13	16	16
Quantity	No.	1	1	1	1	1	1	1
<b>SOUND LEVEL <sup>(9)</sup></b>								
Sound Power - Cooling	dB(A)	89	89	89	89	89	89	89
Sound Pressure@1m - Cooling	dB(A)	79	79	79	79	79	79	79
<b>REFRIGERANT CIRCUIT</b>								
Refrigerant type		R134a	R134a	R134a	R134a	R134a	R134a	R134a
Refrigerant charge	kg	18	35	34	37	37	38	38
N. of circuits	N.	1	1	1	1	1	1	1
<b>PIPING CONNECTIONS <sup>(6)</sup></b>								
Evaporator water inlet/outlet	mm	76.2	76.2	76.2	76.2	76.2	76.2	76.2
Condenser water inlet/outlet	"	2 1/2	4	4	4	4	4	4

**EWWD~J-SS**

Note

- (1) Cooling performances as per EN14511:2013 (evaporator 12.0/7.0°C, condenser 30.0/35.0°C; operating fluid=Water, fouling factor=0 m<sup>2</sup>C/W, unit at full load). The minimum capacity indicated is referred to unit operating at standard Eurovent conditions.
- (2) SEER according to EN14825, fan coils application 12.0/7.0°C water temperature (for indication only).
- (3) SEPR according to EN14825:2018, high temperature process application (for indication only).
- (4) Heating performances:
  - Low temperature application: evaporator 10.0/7.0°C, condenser 30.0/35.0°C; operating fluid=Water, fouling factor=0 m<sup>2</sup>C/W, unit at full load;
  - Intermediate temperature application: evaporator 10.0/7.0°C, condenser 40.0/45.0°C; operating fluid=Water, fouling factor=0 m<sup>2</sup>C/W, unit at full load;
  - Medium temperature application: evaporator 10.0/7.0°C, condenser 47.0/55.0°C; operating fluid=Water, fouling factor=0 m<sup>2</sup>C/W, unit at full load.
- (5)  $\eta_{s,h}$  / SCOP as defined in Directive 2009/125/EC of the European Parliament and of the Council with regard to Ecodesign requirements for space heaters with 400 kW maximum rated capacity - COMMISSION REGULATION (EU) N° 813/2013/EU of 2 August 2013;
  - SCOP as per EN14825, average climate, low temperature application.
- (6) Dimensions and weights are for indication only and not considered binding. Before designing the installation, consult the official drawings available from the factory at request.
- (7) PHE: Plate Heat Exchanger; S&T: Single Pass Shell & Tube
- (8) The values refer to the pressure drops in the evaporator/condenser only.
- (9) Sound power level are measured in accordance with ISO 9614 and Eurovent 8/1 for Eurovent certified units. The certification refers only to the overall sound power level; the sound pressure is calculated from the sound power level and are for information only and not considered binding.

All the data are referred to standard unit without options and are subject to change without notice.

EWWH~J-SS

MODEL		EWWH090 J-SS	EWWH110 J-SS	EWWH120 J-SS	EWWH130 J-SS	EWWH150 J-SS	EWWH180 J-SS	EWWH200 J-SS
<b>COOLING PERFORMANCE <sup>(1)</sup></b>								
Capacity - Cooling	kW	88.69	107.1	115.1	133.5	150.1	181.5	200.8
Capacity control - Type		Stepless	Stepless	Stepless	Stepless	Stepless	Stepless	Stepless
Capacity control - Minimum capacity	%	25	25	25	25	25	25	25
Unit power input - Cooling	kW	20.9	25.3	28.5	33.2	37.3	44.3	50.2
EER		4.24	4.23	4.04	4.03	4.03	4.10	4.00
SEER <sup>(2)</sup>		3.53	3.53	3.47	3.50	3.50	4.09	4.03
$\eta_{s,c}$ <sup>(2)</sup>	%	133.2	133.2	130.8	132.0	132.0	155.6	153.2
SEPR <sup>(3)</sup>		5.85	5.91	5.67	5.67	5.89	6.77	6.63
IPLV		4.42	4.48	4.30	4.32	4.30	4.98	4.88
<b>HEATING PERFORMANCE <sup>(4)</sup></b>								
<b>LOW TEMP. APPLICATION</b>								
Capacity - Heating	kW	105.6	128.9	138.5	160.0	180.7	218.2	243.3
COP		5.03	5.07	4.81	4.78	4.81	4.88	4.80
SCOP <sup>(5a)</sup>		5.01	4.96	4.77	4.77	4.79	5.21	5.10
$\eta_{s,h}$ <sup>(5a)</sup>	%	192.4	190.4	182.8	182.8	183.6	200.4	196.0
<b>INTERMEDIATE TEMP. APPLICATION</b>								
Capacity - Heating	kW	101.8	124.0	133.6	154.2	174.2	212.7	237.6
COP		4.07	4.10	3.90	3.87	3.90	3.84	3.79
<b>MEDIUM TEMP. APPLICATION</b>								
Capacity - Heating	kW	97.74	119.0	128.8	148.6	165.7	207.7	231.9
COP		3.31	3.33	3.18	3.15	3.09	3.09	3.05
SCOP <sup>(5b)</sup>		3.94	3.89	3.75	3.75	3.77	3.89	3.80
$\eta_{s,h}$ <sup>(5b)</sup>	%	149.6	147.6	142.0	142.0	142.8	147.6	144.0
<b>HIGH TEMP. APPLICATION</b>								
Capacity - Heating	kW	93.49	113.6	123.8	142.8	152.5	202.2	225.9
COP		2.68	2.69	2.58	2.56	2.31	2.50	2.46
<b>DIMENSIONS <sup>(6)</sup></b>								
Height	mm	1020	1020	1020	1020	1020	1020	1020
Width	mm	913	913	913	913	913	913	913
Length	mm	2684	2684	2684	2684	2684	2684	2684
<b>WEIGHT <sup>(6)</sup></b>								
Unit Weight	kg	1177	1233	1334	1366	1416	1600	1607
Operating Weight	kg	1211	1276	1378	1415	1473	1663	1675
<b>HEAT EXCHANGER - EVAPORATOR</b>								
Type <sup>(7)</sup>		PHE	PHE	PHE	PHE	PHE	PHE	PHE
Water Volume	l	14	18	14	17	20	26	26
Water flow rate <sup>(1)</sup>	l/s	4.23	5.11	5.49	6.37	7.16	8.66	9.58
Water pressure drop <sup>(1) (8)</sup>	kPa	10.7	10.9	19.3	19.3	17.8	16.8	20.1
<b>HEAT EXCHANGER - CONDENSER</b>								
Type <sup>(7)</sup>		S&T	S&T	S&T	S&T	S&T	S&T	S&T
Water Volume	l	20	20	23	25	29	29	32
Water flow rate <sup>(1)</sup>	l/s	5.17	6.32	6.79	7.84	8.86	10.7	11.9
Water pressure drop <sup>(1) (8)</sup>	kPa	9.1	9.8	8.7	9.1	8.9	12.3	12.1
<b>COMPRESSOR</b>								
Type		Single Screw	Single Screw	Single Screw	Single Screw	Single Screw	Single Screw	Single Screw
Oil charge	l	16	16	16	18	18	19	19
Quantity	No.	1	1	1	1	1	1	1
<b>SOUND LEVEL <sup>(9)</sup></b>								
Sound Power - Cooling	dB(A)	89	89	89	89	89	89	89
Sound Pressure@1m - Cooling	dB(A)	79	79	79	79	79	79	79
<b>REFRIGERANT CIRCUIT</b>								
Refrigerant type		R1234ze	R1234ze	R1234ze	R1234ze	R1234ze	R1234ze	R1234ze
Refrigerant charge	kg	18	35	34	37	37	38	38
N. of circuits	N.	1	1	1	1	1	1	1
<b>PIPING CONNECTIONS <sup>(6)</sup></b>								
Evaporator water inlet/outlet	mm	76.2	76.2	76.2	76.2	76.2	76.2	76.2
Condenser water inlet/outlet	"	2 1/2	4	4	4	4	4	4

**EWWH~J-SS**

Note

- (1) Cooling performances as per EN14511:2018 (evaporator 12.0/7.0°C, condenser 30.0/35.0°C; operating fluid=Water, fouling factor=0 m<sup>2</sup>C/W, unit at full load). The minimum capacity indicated is referred to unit operating at standard Eurovent conditions.
- (2) SEER according to EN14825, fan coils application 12.0/7.0°C water temperature (for indication only).
- (3) SEPR according to EN14825:2018, high temperature process application (for indication only).
- (4) Heating performances:
  - Low temperature application: evaporator 10.0/7.0°C, condenser 30.0/35.0°C; operating fluid=Water, fouling factor=0 m<sup>2</sup>C/W, unit at full load;
  - Intermediate temperature application: evaporator 10.0/7.0°C, condenser 40.0/45.0°C; operating fluid=Water, fouling factor=0 m<sup>2</sup>C/W, unit at full load;
  - Medium temperature application: evaporator 10.0/7.0°C, condenser 47.0/55.0°C; operating fluid=Water, fouling factor=0 m<sup>2</sup>C/W, unit at full load;
  - High temperature application: evaporator 10.0/7.0°C, condenser 55.0/65.0°C; operating fluid=Water, fouling factor=0 m<sup>2</sup>C/W, unit at full load (performances calculated with the option on request 111 High temperature kit, according to the operating limits).
- (5)  $\eta_{s,h}$  / SCOP as defined in Directive 2009/125/EC of the European Parliament and of the Council with regard to Ecodesign requirements for space heaters with 400 kW maximum rated capacity - COMMISSION REGULATION (EU) N° 813/2013/EU of 2 August 2013;
  - a. SCOP as per EN14825, average climate, low temperature application;
  - b. SCOP as per EN14825, average climate, medium temperature application.
- (6) Dimensions and weights are for indication only and not considered binding. Before designing the installation, consult the official drawings available from the factory at request.
- (7) PHE: Plate Heat Exchanger; S&T: Single Pass Shell & Tube
- (8) The values refer to the pressure drops in the evaporator/condenser only.
- (9) Sound power level are measured in accordance with ISO 9614 and Eurovent 8/1 for Eurovent certified units. The certification refers only to the overall sound power level; the sound pressure is calculated from the sound power level and are for information only and not considered binding.

All the data are referred to standard unit without options and are subject to change without notice.



EWWS~J-SS

MODEL		EWWS120 J-SS	EWWS140 J-SS	EWWS150 J-SS	EWWS180 J-SS	EWWS210 J-SS	EWWS240 J-SS	EWWS270 J-SS
<b>COOLING PERFORMANCE <sup>(1)</sup></b>								
Capacity - Cooling	kW	115.1	136.3	154.4	180.7	207.2	241.3	272.1
Capacity control - Type		Stepless	Stepless	Stepless	Stepless	Stepless	Stepless	Stepless
Capacity control - Minimum capacity	%	25	25	25	25	25	25	25
Unit power input - Cooling	kW	29.9	36.3	41.6	47.8	54.2	65.7	74.4
EER		3.84	3.75	3.71	3.78	3.82	3.67	3.66
SEER <sup>(2)</sup>		3.41	3.42	3.37	3.46	3.47	3.91	3.88
$\eta_{s,c}$ <sup>(2)</sup>	%	128.4	128.8	126.8	130.4	130.8	148.4	147.2
SEPR <sup>(3)</sup>		5.42	5.44	5.51	5.35	5.56	6.27	6.17
IPLV		4.14	4.17	4.13	4.14	4.16	4.66	4.61
<b>HEATING PERFORMANCE <sup>(4)</sup></b>								
<b>LOW TEMP. APPLICATION</b>								
Capacity - Heating	kW	140.4	171.3	192.1	220.6	247.6	303.2	338
COP		4.64	4.68	4.55	4.56	4.51	4.56	4.48
SCOP <sup>(5a)</sup>		4.57	4.47	4.37	4.49	4.58	4.68	4.66
$\eta_{s,h}$ <sup>(5a)</sup>	%	174.8	170.8	166.8	171.6	175.2	179.2	178.4
<b>INTERMEDIATE TEMP. APPLICATION</b>								
Capacity - Heating	kW	134.5	163.9	184.8	211.7	237.6	293.0	328.0
COP		3.75	3.78	3.70	3.70	3.66	3.61	3.55
<b>MEDIUM TEMP. APPLICATION</b>								
Capacity - Heating	kW	128.3	156.1	177.0	202.9	223.4	282.3	316.8
COP		3.05	3.07	3.02	3.02	2.88	2.89	2.86
SCOP <sup>(5b)</sup>		3.61	3.51	3.49	3.54	3.58	3.50	3.49
$\eta_{s,h}$ <sup>(5b)</sup>	%	136.4	132.4	131.6	133.6	135.2	132.0	131.6
<b>DIMENSIONS <sup>(6)</sup></b>								
Height	mm	1020	1020	1020	1020	1020	1020	1020
Width	mm	913	913	913	913	913	913	913
Length	mm	2684	2684	2684	2684	2684	2684	2684
<b>WEIGHT <sup>(6)</sup></b>								
Unit Weight	kg	1177	1233	1334	1366	1416	1600	1607
Operating Weight	kg	1211	1276	1378	1415	1473	1663	1675
<b>HEAT EXCHANGER - EVAPORATOR</b>								
Type <sup>(7)</sup>		PHE	PHE	PHE	PHE	PHE	PHE	PHE
Water Volume	l	14	18	14	17	20	26	26
Water flow rate <sup>(1)</sup>	l/s	5.49	6.51	7.37	8.62	9.89	11.50	13.00
Water pressure drop <sup>(1) (8)</sup>	kPa	17.1	16.8	32.7	33.4	31.8	28.0	34.7
<b>HEAT EXCHANGER - CONDENSER</b>								
Type <sup>(7)</sup>		S&T	S&T	S&T	S&T	S&T	S&T	S&T
Water Volume	l	20	20	23	25	29	29	32
Water flow rate <sup>(1)</sup>	l/s	6.87	8.38	9.37	10.80	12.10	14.80	16.50
Water pressure drop <sup>(1) (8)</sup>	kPa	15.0	16.1	15.3	15.9	15.4	22.0	21.6
<b>COMPRESSOR</b>								
Type		Single Screw	Single Screw	Single Screw	Single Screw	Single Screw	Single Screw	Single Screw
Oil charge	l	16	16	16	18	18	19	19
Quantity	No.	1	1	1	1	1	1	1
<b>SOUND LEVEL <sup>(9)</sup></b>								
Sound Power - Cooling	dB(A)	89	89	89	89	89	89	89
Sound Pressure@1m - Cooling	dB(A)	79	79	79	79	79	79	79
<b>REFRIGERANT CIRCUIT</b>								
Refrigerant type		R513A	R513A	R513A	R513A	R513A	R513A	R513A
Refrigerant charge	kg	18	35	34	37	37	38	38
N. of circuits	N.	1	1	1	1	1	1	1
<b>PIPING CONNECTIONS <sup>(6)</sup></b>								
Evaporator water inlet/outlet	mm	76.2	76.2	76.2	76.2	76.2	76.2	76.2
Condenser water inlet/outlet	"	2 1/2	4	4	4	4	4	4

**EWWS~J-SS**

Note

- (1) Cooling performances as per EN14511:2018 (evaporator 12.0/7.0°C, condenser 30.0/35.0°C; operating fluid=Water, fouling factor=0 m<sup>2</sup>C/W, unit at full load). The minimum capacity indicated is referred to unit operating at standard Eurovent conditions.
- (2) SEER according to EN14825, fan coils application 12.0/7.0°C water temperature (for indication only).
- (3) SEPR according to EN14825:2018, high temperature process application (for indication only).
- (4) Heating performances:
  - Low temperature application: evaporator 10.0/7.0°C, condenser 30.0/35.0°C; operating fluid=Water, fouling factor=0 m<sup>2</sup>C/W, unit at full load;
  - Intermediate temperature application: evaporator 10.0/7.0°C, condenser 40.0/45.0°C; operating fluid=Water, fouling factor=0 m<sup>2</sup>C/W, unit at full load;
  - Medium temperature application: evaporator 10.0/7.0°C, condenser 47.0/55.0°C; operating fluid=Water, fouling factor=0 m<sup>2</sup>C/W, unit at full load.
- (5)  $\eta_{s,h}$  / SCOP as defined in Directive 2009/125/EC of the European Parliament and of the Council with regard to Ecodesign requirements for space heaters with 400 kW maximum rated capacity - COMMISSION REGULATION (EU) N° 813/2013/EU of 2 August 2013;
  - a. SCOP as per EN14825, average climate, low temperature application;
  - b. SCOP as per EN14825, average climate, medium temperature application.
- (6) Dimensions and weights are for indication only and not considered binding. Before designing the installation, consult the official drawings available from the factory at request.
- (7) PHE: Plate Heat Exchanger; S&T: Single Pass Shell & Tube
- (8) The values refer to the pressure drops in the evaporator/condenser only.
- (9) Sound power level are measured in accordance with ISO 9614 and Eurovent 8/1 for Eurovent certified units. The certification refers only to the overall sound power level; the sound pressure is calculated from the sound power level and are for information only and not considered binding.

All the data are referred to standard unit without options and are subject to change without notice.

**EWWD~J-SS**

MODEL		EWWD120 J-SS	EWWD140 J-SS	EWWD150 J-SS	EWWD180 J-SS	EWWD210 J-SS	EWWD250 J-SS	EWWD280 J-SS
<b>POWER SUPPLY</b>								
Phases	N.	3	3	3	3	3	3	3
Frequency <sup>(2)</sup>	Hz	50	50	50	50	50	50	50
Voltage <sup>(2)</sup>	V	400	400	400	400	400	400	400
Voltage tolerance Minimum	%	-10	-10	-10	-10	-10	-10	-10
Voltage tolerance Maximum	%	+10	+10	+10	+10	+10	+10	+10
<b>UNIT</b>								
Maximum inrush current	A	153	153	197	197	197	290	290
Nominal running current cooling <sup>(1)</sup>	A	48	57	67	74	83	97	109
Maximum running current <sup>(3)</sup>	A	85	103	114	130	154	178	201
Maximum current for wires sizing <sup>(4)</sup>	A	95	114	127	144	172	197	223
Starting method		Y-Δ	Y-Δ	Y-Δ	Y-Δ	Y-Δ	Y-Δ	Y-Δ

**EWWH~J-SS**

MODEL		EWWH090 J-SS	EWWH110 J-SS	EWWH120 J-SS	EWWH130 J-SS	EWWH150 J-SS	EWWH180 J-SS	EWWH200 J-SS
<b>POWER SUPPLY</b>								
Phases	N.	3	3	3	3	3	3	3
Frequency <sup>(2)</sup>	Hz	50	50	50	50	50	50	50
Voltage <sup>(2)</sup>	V	400	400	400	400	400	400	400
Voltage tolerance Minimum	%	-10	-10	-10	-10	-10	-10	-10
Voltage tolerance Maximum	%	+10	+10	+10	+10	+10	+10	+10
<b>UNIT</b>								
Maximum inrush current	A	153	153	197	197	197	290	290
Nominal running current cooling <sup>(1)</sup>	A	39	44	55	60	65	76	84
Maximum running current <sup>(3)</sup>	A	75	90	100	114	143	158	178
Maximum current for wires sizing <sup>(4)</sup>	A	83	100	112	127	159	176	198
Starting method		Y-Δ	Y-Δ	Y-Δ	Y-Δ	Y-Δ	Y-Δ	Y-Δ

**EWWS~J-SS**

MODEL		EWWS120 J-SS	EWWS140 J-SS	EWWS150 J-SS	EWWS180 J-SS	EWWS210 J-SS	EWWS240 J-SS	EWWS270 J-SS
<b>POWER SUPPLY</b>								
Phases	N.	3	3	3	3	3	3	3
Frequency <sup>(2)</sup>	Hz	50	50	50	50	50	50	50
Voltage <sup>(2)</sup>	V	400	400	400	400	400	400	400
Voltage tolerance Minimum	%	-10	-10	-10	-10	-10	-10	-10
Voltage tolerance Maximum	%	+10	+10	+10	+10	+10	+10	+10
<b>UNIT</b>								
Maximum inrush current	A	154	154	198	198	198	291	291
Nominal running current cooling <sup>(1)</sup>	A	50	60	70	78	87	105	117
Maximum running current <sup>(3)</sup>	A	81	96	108	122	141	164	185
Maximum current for wires sizing <sup>(4)</sup>	A	89	107	120	136	158	183	207
Starting method		Y-Δ	Y-Δ	Y-Δ	Y-Δ	Y-Δ	Y-Δ	Y-Δ

*Note*

- (1) Nominal running current in cooling is referred to the following conditions: evaporator 12.0/7.0°C, condensing temperature 45°C; operating fluid=Water, fouling factor=0 m<sup>2</sup>°C/W, unit at full load.
- (2) Allowed voltage tolerance ± 10%. Voltage unbalance between phases must be within ± 3%.
- (3) Maximum running current is based on max compressor absorbed current in its envelope.
- (4) Maximum current for wires sizing is based on minimum allowed voltage.

All the data are referred to standard unit without options. All data are subject to change without notice. Please refer to unit nameplate data.

**EWW(D)(H)(S)~J-SS**

EWW( )~J			Sound pressure level at 1 m from the unit (rif. 2 x 10 <sup>-5</sup> Pa)								Power Level Lw dB(A)	
(D)	(H)	(S)	63 Hz	125 Hz	250 Hz	500 Hz	1000 Hz	2000 Hz	4000 Hz	8000 Hz		Lp dB(A)
<i>R134a</i>	<i>R1234ze</i>	<i>R513A</i>										
MODEL												
<b>120</b>	<b>090</b>	<b>120</b>	64.6	69.1	74.1	78.5	73.6	71.2	58.6	55.7	<b>79</b>	<b>89</b>
<b>140</b>	<b>110</b>	<b>140</b>	64.6	69.1	74.1	78.5	73.6	71.2	58.6	55.7	<b>79</b>	<b>89</b>
<b>150</b>	<b>120</b>	<b>150</b>	64.6	69.1	74.1	78.5	73.6	71.2	58.6	55.7	<b>79</b>	<b>89</b>
<b>180</b>	<b>130</b>	<b>180</b>	64.6	69.1	74.1	78.5	73.6	71.2	58.6	55.7	<b>79</b>	<b>89</b>
<b>210</b>	<b>150</b>	<b>210</b>	64.6	69.1	74.1	78.5	73.6	71.2	58.6	55.7	<b>79</b>	<b>89</b>
<b>250</b>	<b>180</b>	<b>240</b>	67.3	67.3	72.8	77.8	72.3	73.3	62.3	58.8	<b>79</b>	<b>89</b>
<b>280</b>	<b>200</b>	<b>270</b>	67.3	67.3	72.8	77.8	72.3	73.3	62.3	58.8	<b>79</b>	<b>89</b>

**EWW(D)(H)(S)~J-SS + OP76-b (sound proof system compressor)**

EWW( )~J + OP76-b			Sound pressure level at 1 m from the unit (rif. 2 x 10 <sup>-5</sup> Pa)								Power Level Lw dB(A)	
(D)	(H)	(S)	63 Hz	125 Hz	250 Hz	500 Hz	1000 Hz	2000 Hz	4000 Hz	8000 Hz		Lp dB(A)
<i>R134a</i>	<i>R1234ze</i>	<i>R513A</i>										
MODEL												
<b>120</b>	<b>090</b>	<b>120</b>	61.6	66.1	71.1	75.5	70.6	68.2	55.6	52.7	<b>76</b>	<b>86</b>
<b>140</b>	<b>110</b>	<b>140</b>	61.6	66.1	71.1	75.5	70.6	68.2	55.6	52.7	<b>76</b>	<b>86</b>
<b>150</b>	<b>120</b>	<b>150</b>	61.6	66.1	71.1	75.5	70.6	68.2	55.6	52.7	<b>76</b>	<b>86</b>
<b>180</b>	<b>130</b>	<b>180</b>	61.6	66.1	71.1	75.5	70.6	68.2	55.6	52.7	<b>76</b>	<b>86</b>
<b>210</b>	<b>150</b>	<b>210</b>	61.6	66.1	71.1	75.5	70.6	68.2	55.6	52.7	<b>76</b>	<b>86</b>
<b>250</b>	<b>180</b>	<b>240</b>	64.3	64.3	69.8	74.8	69.3	70.3	59.3	55.8	<b>76</b>	<b>86</b>
<b>280</b>	<b>200</b>	<b>270</b>	64.3	64.3	69.8	74.8	69.3	70.3	59.3	55.8	<b>76</b>	<b>86</b>

**Note:**

Sound power level (referred to evaporator 12.0/7.0 °C, condenser 30.0/35.0 °C; operating fluid=Water, fouling factor=0 m<sup>2</sup>C/W, unit at full load) are measured in accordance with ISO 9614 and Eurovent 8/1 for Eurovent certified units. The certification refers only to the overall sound power level.

The sound data in the Octave band spectrum is for intended for reference only and not considering binding.

The sound pressure is calculated from the sound power level and are for information only and not considered binding.

The data are referred to the standard unit without options.

**Operating Limits - EWWD~J-SS (R-134a)**

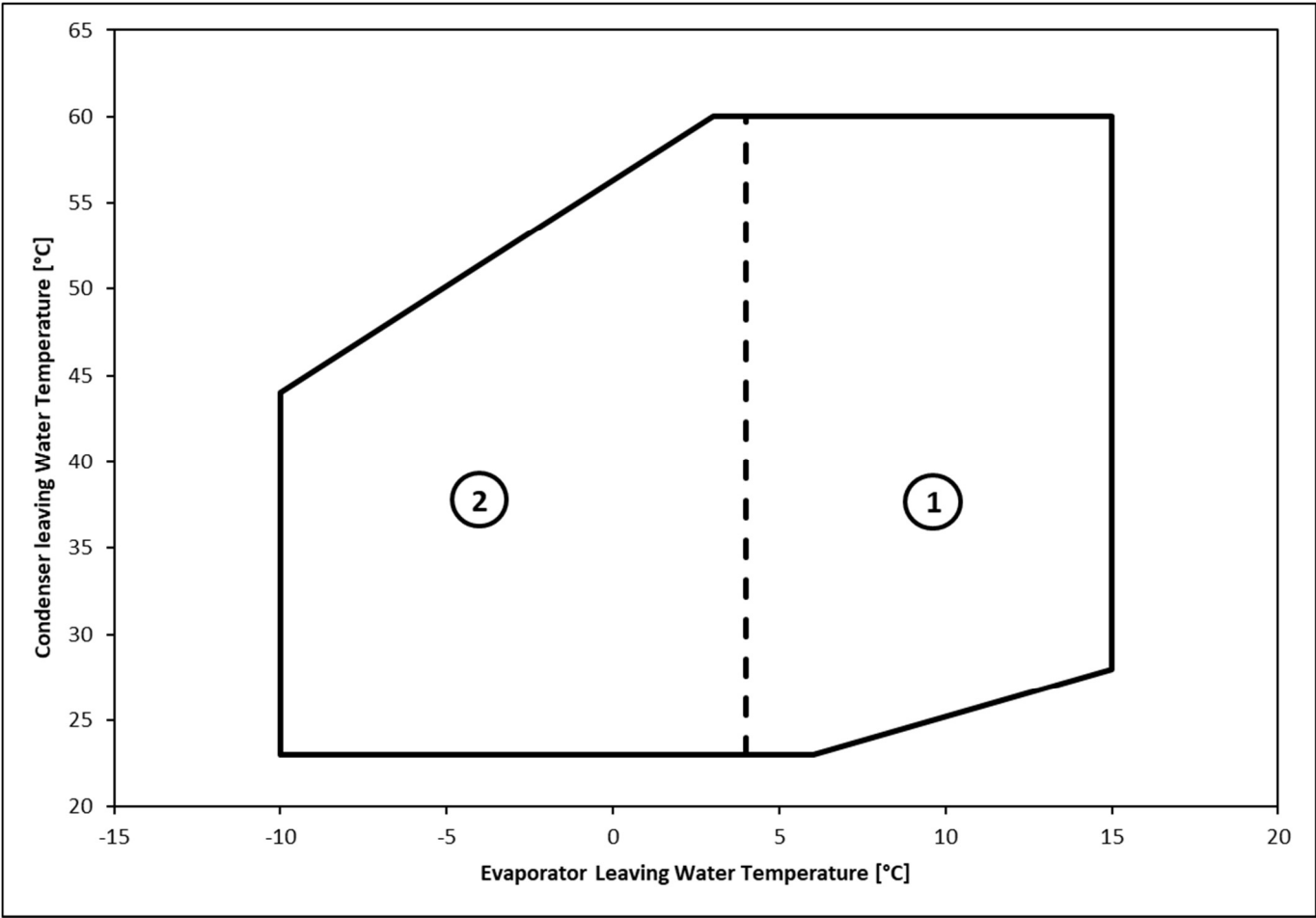

**Legend:**

ELWT: Evaporator Leaving Water Temperature (°C) CLWT: Condenser Leaving Water Temperature (°C)

**Ref. 1:** Standard Unit.

**Ref. 2:** Standard Unit + Brine Version (option 08 - on request).

**Operating Limits - EWWH~J-SS (R-1234ze)**

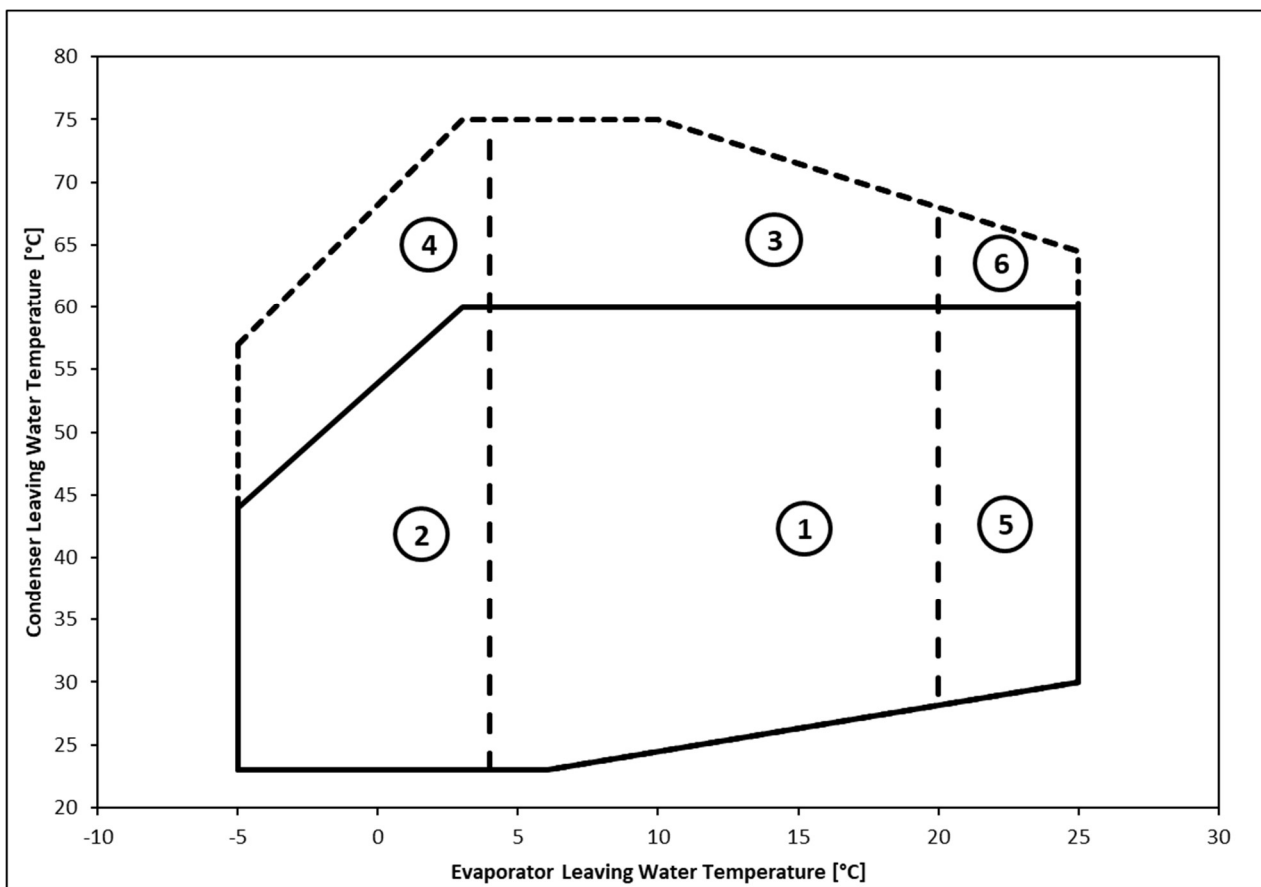

**Legend:**

ELWT: Evaporator Leaving Water Temperature (°C) CLWT: Condenser Leaving Water Temperature (°C)

**Ref. 1:** Standard Unit.

**Ref. 2:** Standard Unit + Brine Version (option 08 - on request).

**Ref. 3:** Standard Unit + High temperature kit (option 111 - on request).

**Ref. 4:** Standard Unit + High temperature kit (option 111 - on request) + Brine Version (option 08 - on request).

**Ref. 5:** Standard Unit + High leaving water temperature (option 189 - on request).

**Ref. 6:** Standard Unit + High leaving water temperature (option 189 - on request) + High temperature kit (option 111 - on request).

**Operating Limits - EWWS~J-SS (R-513A)**

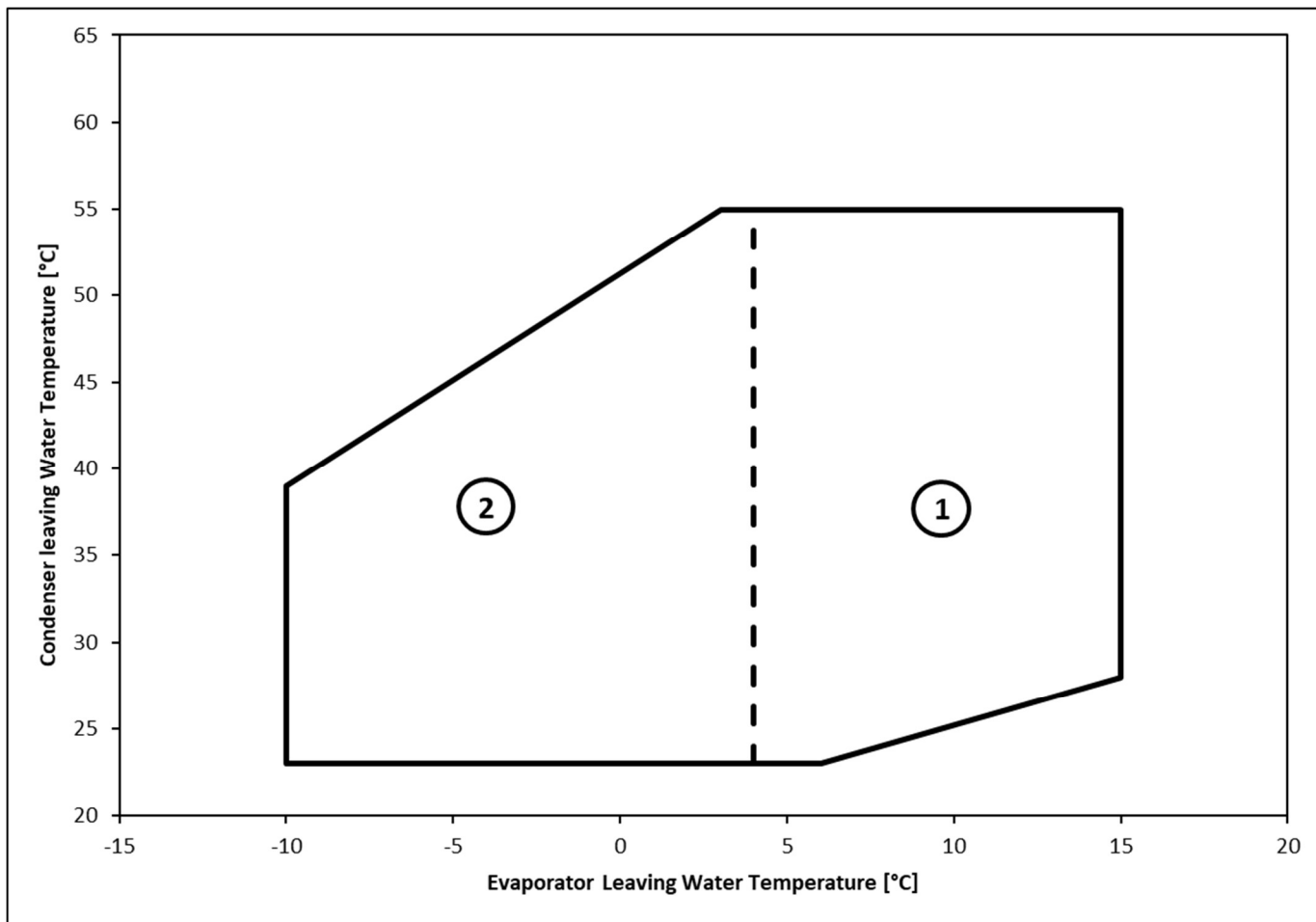

**Legend:**

ELWT: Evaporator Leaving Water Temperature (°C) CLWT: Condenser Leaving Water Temperature (°C)

**Ref. 1:** Standard Unit.

**Ref. 2:** Standard Unit + Brine Version (option 08 - on request).

**Notes:**

- The above graphs represent a guideline about the operating limits. Please refer to Chiller Selection Software (CSS) for real operating limits working conditions for each size.
- For operation with EWLWT below 4°C, the unit must operate with glycol mixture. The glycol percentage must be provided according to the minimum ELWT needed.

**Water heat exchangers - maximum/maximum water  $\Delta T$** 

The minimum and maximum standard allowed  $\Delta T$  at full load standard conditions are respectively 4°C and 8°C. These values represent a guideline, please refer to the latest Chiller Selection Software (CSS) for real minimum and maximum allowed  $\Delta T$  each size. With the option Four passes condenser OP.54B it is possible to reach up to 20°C max  $\Delta T$ .

**Requirements for operation and storage**

Unit is designed for indoor installation only.

Environmental conditions must be within the following limits:

Limits for storage:

- Maximum ambient temperature 55°C
- Minimum ambient temperature: 5°C
- Maximum relative humidity: 95% not condensing

Storage below the minimum temperature may cause damage to components.

Storage above the maximum temperature causes opening of safety valves.

Storage in condensing atmosphere may damage electronic components.

**Water treatment**

Before putting the unit into operation, clean the water circuit. Dirt, scales, corrosion debris and other materials can accumulate inside the heat exchanger and reduce its heat exchanging capacity. Pressure drops can increase as well, thus reducing water flow. Proper water treatment therefore reduces the risk of corrosion, erosion, scaling, etc. The most appropriate water treatment must be determined locally, according to the type of system and water characteristics. The manufacturer is not responsible for damage to or malfunctioning of equipment caused by improperly treated water.



**Water treatment** Before putting the unit into operation, clean the water circuit. Dirt, scales, corrosion debris and other material can accumulate inside the heat exchanger and reduce its heat exchanging capacity. Pressure drop can increase as well, thus reducing water flow. Proper water treatment therefore reduces the risk of corrosion, erosion, scaling, etc.. The most appropriate water treatment must be determined locally, according to the type of system and water characteristics. The manufacturer is not responsible for damage to or malfunctioning of equipment caused by failure to treat water or by improperly treated water.

Water quality requirements	Shell&tube + Flooded	BPHE
Ph (25 °C)	6.8 ÷ 8.4	7.5 – 9.0
Electrical conductivity [ $\mu$ S/cm] (25°C)	< 800	< 500
Chloride ion [mg Cl <sup>-</sup> / l]	< 150	< 70 (HP <sup>1</sup> ); < 300 (CO <sup>2</sup> )
Sulphate ion [mg SO <sub>4</sub> <sup>2-</sup> / l]	< 100	< 100
Alkalinity [mg CaCO <sub>3</sub> / l]	< 100	< 200
Total Hardness [mg CaCO <sub>3</sub> / l]	< 200	75 ÷ 150
Iron [mg Fe / l]	< 1	< 0.2
Ammonium ion [mg NH <sup>4+</sup> / l]	< 1	< 0.5
Silica [mg SiO <sub>2</sub> / l]	< 50	-
Chlorine molecular (mg Cl <sub>2</sub> /l)	< 5	< 0.5

Note: 1. Heat Pump  
2. Cooling Only

**Installation notes**

**Warning** Installation and maintenance of the unit must be performed only by qualified personnel who have knowledge with local codes and regulations, and experience with this type of equipment. Must be avoided the unit installation in places that could be considered dangerous for all the maintenance operations.

**Handling** Avoid bumping and/or jolting during loading/unloading unit from the truck and moving it. Secure the unit inside the truck to prevent it from moving and causing damages. Do not allow any part of the unit to fall during transportation or loading/unloading.

Use extreme caution when handling the unit to prevent damage to the control or the refrigerant piping. The unit must be lifted by attaching cables or chains at the lifting holes in each corner. For more information please refer to the unit Installation Manual.

**Location** Unit is designed for indoor installation only. The unit must be mounted on a leveled base of concrete or steel. The unit must be installed on a robust and perfectly leveled foundation; it might be necessary to use weight distribution beams. Rubber-in-shear isolators can be furnished and field placed under each corner of the package. A rubber anti-skid pad should be used under isolators if hold-down bolts are not used. Vibration isolator in all water piping connected to the chiller is recommended to avoid straining the piping and transmitting vibration and noise.

**Space requirements** Every side of the unit must be accessible for all post installation maintenance activities. The minimum space required is shown on the following drawing:

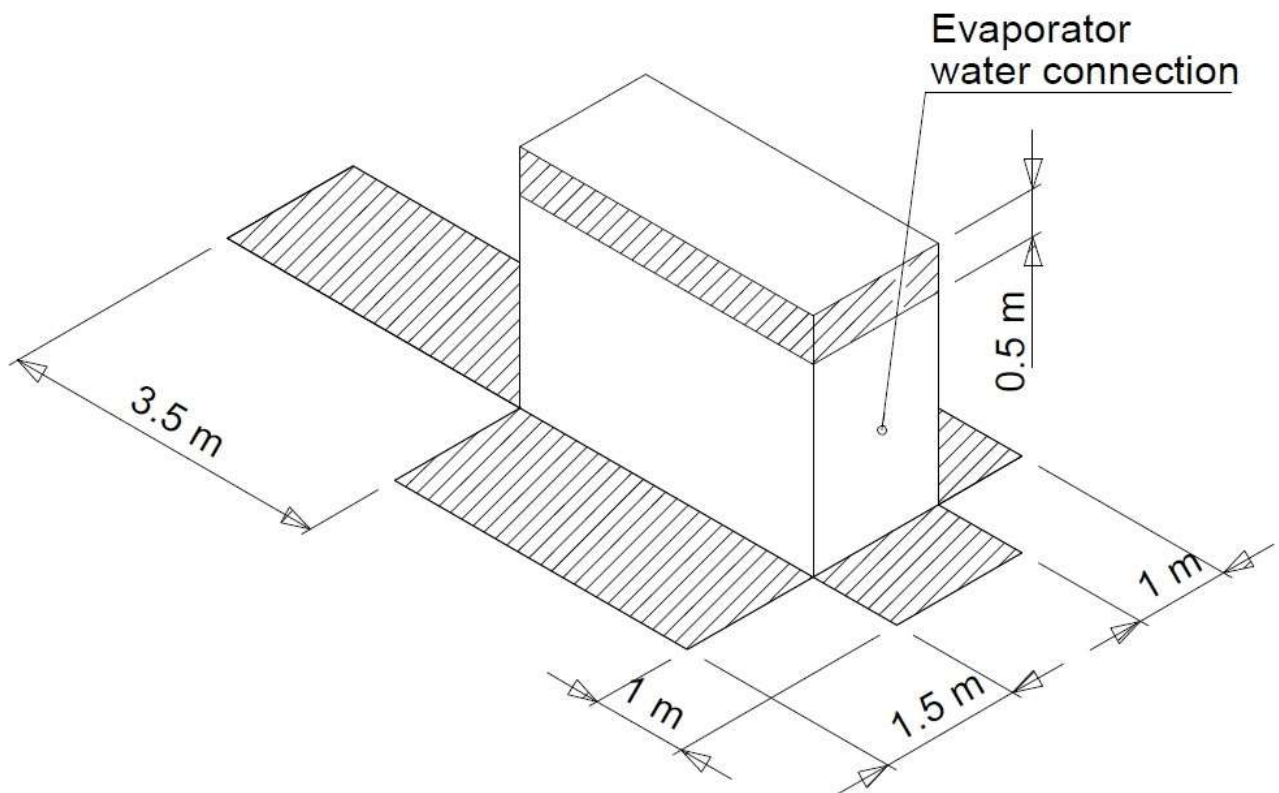

**Acoustic protection** When noise level must meet special requirements, it is necessary to pay the maximum attention to ensure the perfect insulation of the unit from the support base by applying appropriate anti-vibration devices on the unit, on the water pipes and on the electrical connections.

**Technical specifications**

**General** The unit will be designed and manufactured in accordance with the following European directives:

- Construction of pressure vessel 2014/68/EU
- Machinery Directive 2006/42/EC
- Low Voltage 2014/35/EU
- Electromagnetic Compatibility 2014/30/EU
- Electrical & Safety codes EN60204-1/EN61439-1/EN61439-2
- Manufacturing & Quality Standards UNI EN ISO 9001:2008
- Environmental Management System UNI EN ISO 14001:2004
- Health & Safety Management System BS OHSAS 18001:2007

To avoid any losses, the unit will be tested at full load in the factory (at the nominal working conditions and water temperatures). The unit will be delivered to the job site completely assembled and charged with refrigerant and oil. The installation of the chiller must comply with the manufacturer's instructions for rigging and handling equipment.

The unit will be able to start up and operate (as standard) at full load with:

- evaporator leaving fluid temperature between..... °C and..... °C
- condenser leaving fluid temperature between..... °C and..... °C

**Refrigerant** HFO R1234ze(e), HFO R513A, HFC R134a

**Performance** Unit shall supply the following performances:

- Number of chiller(s): ..... unit(s)
- Cooling capacity for single chiller: ..... kW
- Power input for single chiller in cooling mode: ..... kW
- Evaporator heat exchanger entering water temperature in cooling mode: ..... °C
- Evaporator heat exchanger leaving water temperature in cooling mode: ..... °C
- Evaporator heat exchanger water flow: ..... l/s
- Condenser heat exchanger entering water temperature in cooling mode: ..... °C
- Condenser heat exchanger leaving water temperature in cooling mode: ..... °C
- Condenser heat exchanger water flow: ..... l/s

Operating voltage range should be 400V ±10%, 3ph, 50Hz (or 380V ±10%, 3ph, 60Hz), voltage unbalance maximum 3%, without neutral conductor and shall only have one power connection point.

**Unit description** Chiller shall include as standard: one refrigerant circuit, semi-hermetic type rotary single screw compressor, electronic expansion device (EEXV), refrigerant direct expansion plate to plate heat exchanger, water-cooled 'shell&tube' heat exchanger condenser section, R134a refrigerant, lubrication system, motor starting components, discharge line shut-off valve, suction line shut-off valve, control system and all components necessary for safe and stable unit operation.

Chiller will be factory assembled on a robust base-frame made of galvanized steel, protected by an epoxy paint.

**Sound level and vibrations** Sound pressure level at 1 meter distance in free field, semispherical conditions, shall not exceed .....dB(A). The sound pressure levels must be rated in accordance to ISO 3744. Vibration on the base frame should not exceed 2 mm/s.

**Dimensions** Unit dimensions shall not exceed following indications:

Unit length..... mm

Unit width..... mm

Unit height..... mm

**Compressors** The unit shall be equipped with:

- Semi-hermetic, single-screw type with one main helical rotor and two gate rotors. The gate rotors will be constructed of a carbon impregnated engineered composite material. The gate rotor supports will be constructed of cast iron.

- The oil injection shall be used in order to get high EER (Energy Efficiency Ratio) also at high condensing pressure and low sound pressure levels in each load condition.

- Refrigerant system differential pressure shall provide oil flow through service replaceable, 0.5-micron, full flow, cartridge type oil filter internal to compressor.
- Refrigerant system differential pressure shall provide oil injection on all moving compressor parts to correctly lubricate them. Electrical oil pump lubricating system is not acceptable.
- The compressor's oil cooling must be realized, when necessary, by refrigerant liquid injection. External dedicated heat exchanger and additional piping to carry the oil from the compressor to heat exchanger and vice versa will be not accepted.
- The compressor shall be provided with an integrated high efficiency oil separator and with built-in oil filter, cartridge type.
- The compressor shall be direct driven type, without gear transmission between the screw and the electrical motor.
- Compressor shall be equipped with two thermal protections realized by means of thermistors for high temperature protection: one temperature sensor to protect electrical motor and another sensor to protect unit and lubricating oil from high discharge gas temperature.
- The compressor shall be equipped with an electric oil-crankcase heater.
- Compressor shall be fully field serviceable.

**Evaporator** The units shall be equipped with a direct expansion plate to plate type evaporator.

- The evaporator will be made of of stainless-steel brazed plates and shall be linked with an electrical heater to prevent freezing down to -28°C ambient temperature, controlled by a thermostat and shall be insulated with flexible, closed cell polyurethane insulation material (20-mm thick).
- The evaporator will have 1 refrigerant circuit for each compressor.
- The water connections shall be VICTAULIC type connections as standard to ensure quick mechanical disconnection between the unit and the hydronic network.
- The evaporator will be manufactured in accordance to PED approval.
- Flow switch will be standard factory mounted.
- Water filter will be standard.

**Condenser** The unit is equipped with two passes shell & tube condenser with water flowing inside the tubes and refrigerant condensing outside.

- The bottom of the condenser is provided with subcooler section for better refrigerant capacity.
- The tubes are enhanced for maximum heat transfer and rolled into steel tube sheet and sealed. The tubes are individually replaceable.
- The condensers are designed according to the 97/23/EC directive (PED).
- The water side is designed for 16 bar of maximum operating pressure; vents and drain are provided.

**Refrigerant circuit** The unit shall have one independent refrigerant circuit.

The circuit shall include as standard: electronic expansion device piloted by unit's microprocessor control, compressor discharge shut-off valve, liquid line shut-off valve, sight glass with moisture indicator, replaceable filter drier, charging valves, high pressure switch, high and low pressure transducers, oil pressure transducer and insulated suction line.

**Condensation control** The compressor automatically unloads when high condensing pressure is detected. This to prevent the shutdown of the refrigerant circuit (shutdown of the unit) due to a high-pressure fault.

**Low sound unit configurations (on request)** The chiller shall be provided with an acoustical compressor enclosure. This enclosure shall be realized with a light, corrosion resistant aluminum structure and metal panels. The compressor sound- proof enclosure shall be internally fitted with flexible, multi-layer, high density materials.

**Electrical control panel** Power and control shall be located in the main panel that will be manufactured to ensure protection against all weather conditions.

- The electrical panel shall be IP54 and (with the doors opened) internally protected against possible accidental contact with electrical components (IP20).
- The main panel shall be fitted with a main switch interlocked door.
- The power section will include compressors protection devices, compressors starters and control circuit power supply.

**Controller** The controller will be installed as standard and it will be used to modify unit set-points and check control parameters.

- A built-in display will allow easy access to chiller operating status including water temperatures and refrigerant pressures and temperatures.
- A sophisticated software with predictive logic will select the most energy efficient combination of compressor load and electronic expansion valve position keeping stable operating conditions and maximizing chiller efficiency and reliability. In addition to normal operating functionalities, unit controller will take corrective actions in case the chiller operating outside recommended working conditions.

- Unit controller shall be able to protect critical unit components thanks to the signals received by the various unit sensors (such as motor temperature sensors, refrigerant and oil pressure/temperature sensors, pressure switches.....etc..).

**Controller main features** Controller shall guarantee following minimum functions:

- Optimized management of compressors stepless capacity.
- Unit enabled to work in partial failure condition.
- Optimized management of compressor load.
- Visualization of:
  - cooling and heating entering/leaving water temperature of heat exchangers;
  - outdoor ambient temperature;
  - condensing-evaporating temperature and pressure, suction and discharge superheat for each circuit;
  - hours and starts counter for compressors and pumps;
  - status safety devices.
- Control of cooling or heating leaving water temperatures.
- Re-start in case of power failure (automatic or manual depending on failure type).
- Soft load (optimized management of the compressor load during the start-up).
- Start at high heat exchanger water temperature;
- Return Reset (Set Point Reset based on return water temperature);
- Set point Reset (optional);
- Managed operations during critical conditions:
  - High ambient temperature;
  - High thermal load;
  - Startup with high and low differential operating conditions;
  - Startup with high entering water temperature in cooling mode;
  - Startup with low entering water temperature in heating mode;
- Master/Slave operation (up to 4 chillers connected).

Controller shall guarantee following minimum alarms signaling:

- Phase loss.
- Evaporator water flow loss.
- Evaporator water freezing protection.
- External alarm.
- Low evaporator refrigerant pressure.
- High refrigerant pressure (transducer).
- High refrigerant pressure (switch).
- Low pressure ratio.
- High refrigerant discharge temperature.
- High oil pressure differential.
- High motor temperature.

**High Level Communications Interface (on request)** The chiller shall be able to communicate to BMS (Building Management System) based on the most common protocols such as:

- ModbusRTU
- LonWorks
- BacNet BTP certified over IP and MS/TP (class 4) (Native)
- Ethernet TCP/IP.

The present document is drawn up by way of information only and does not constitute an offer binding upon Daikin Applied Europe. Daikin Applied Europe has compiled the content of this document to the best of its knowledge. No express or implied warranty is given for the completeness, accuracy, reliability of fitness to particular purpose of its content and the products and services presented therein. Specifications are subject to change without prior notices. Daikin Applied Europe explicitly rejects any liability for any direct or indirect damage, in the broadest sense, arising from or related to the use and/or interpretation of this document.

**Daikin Applied Europe S.p.A.**

Società unipersonale soggetta ad attività di direzione e coordinamento di Daikin Industries Ltd

Sede Legale: Via Piani di S. Maria, 72  
00040 Ariccia (Roma), Italia  
Sede Amm.va: S.S. Nettunense Km 12+300  
00040 Cecchina (Roma), Italia

T +39 06 93 73 11  
F +39 06 93 74 0 14

